

LEHMBAU
ENTWICKLUNG
ANTONIA LICHT

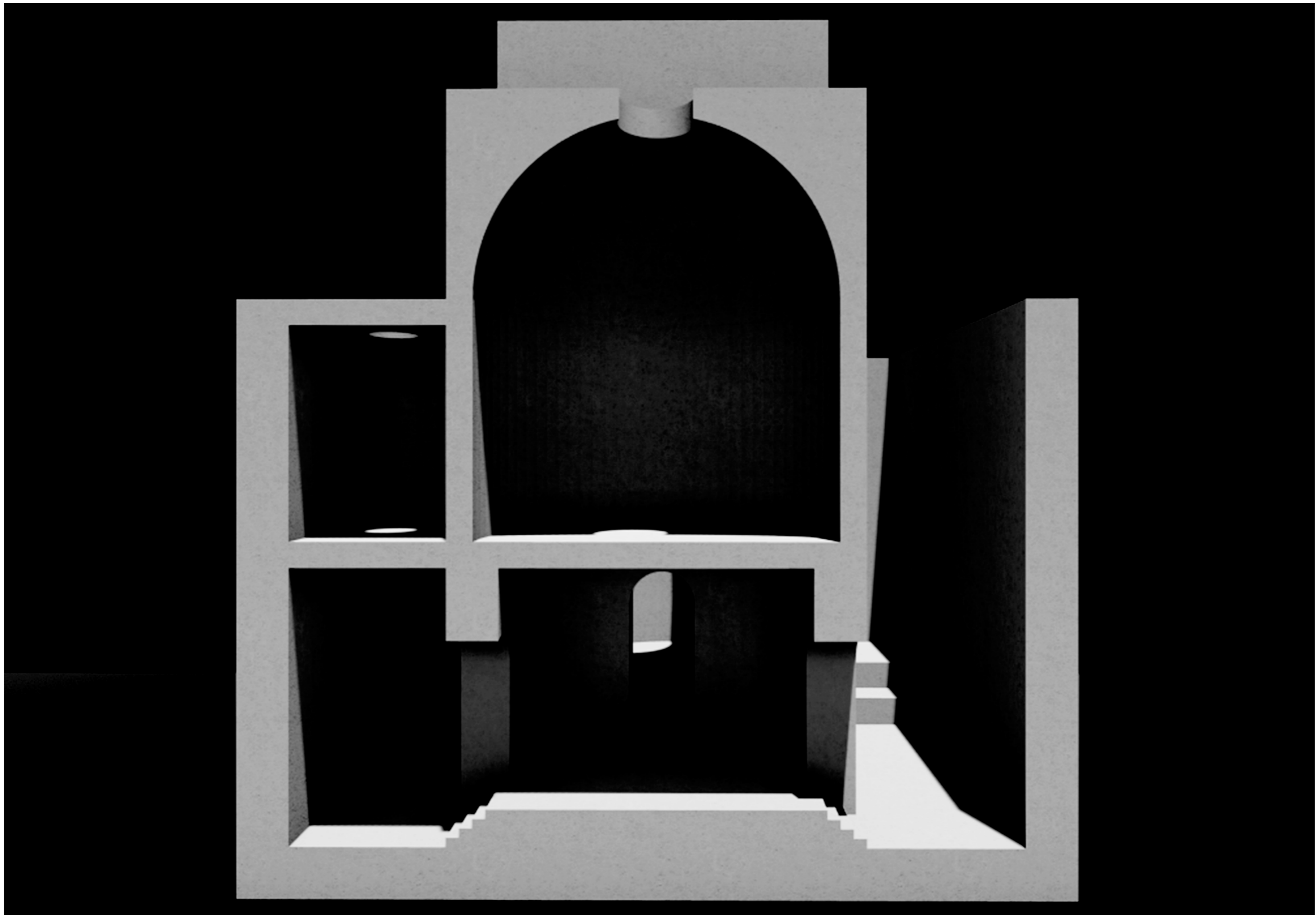

LEHMBAU
ARBEITSMODELL
ANTONIA LICHT

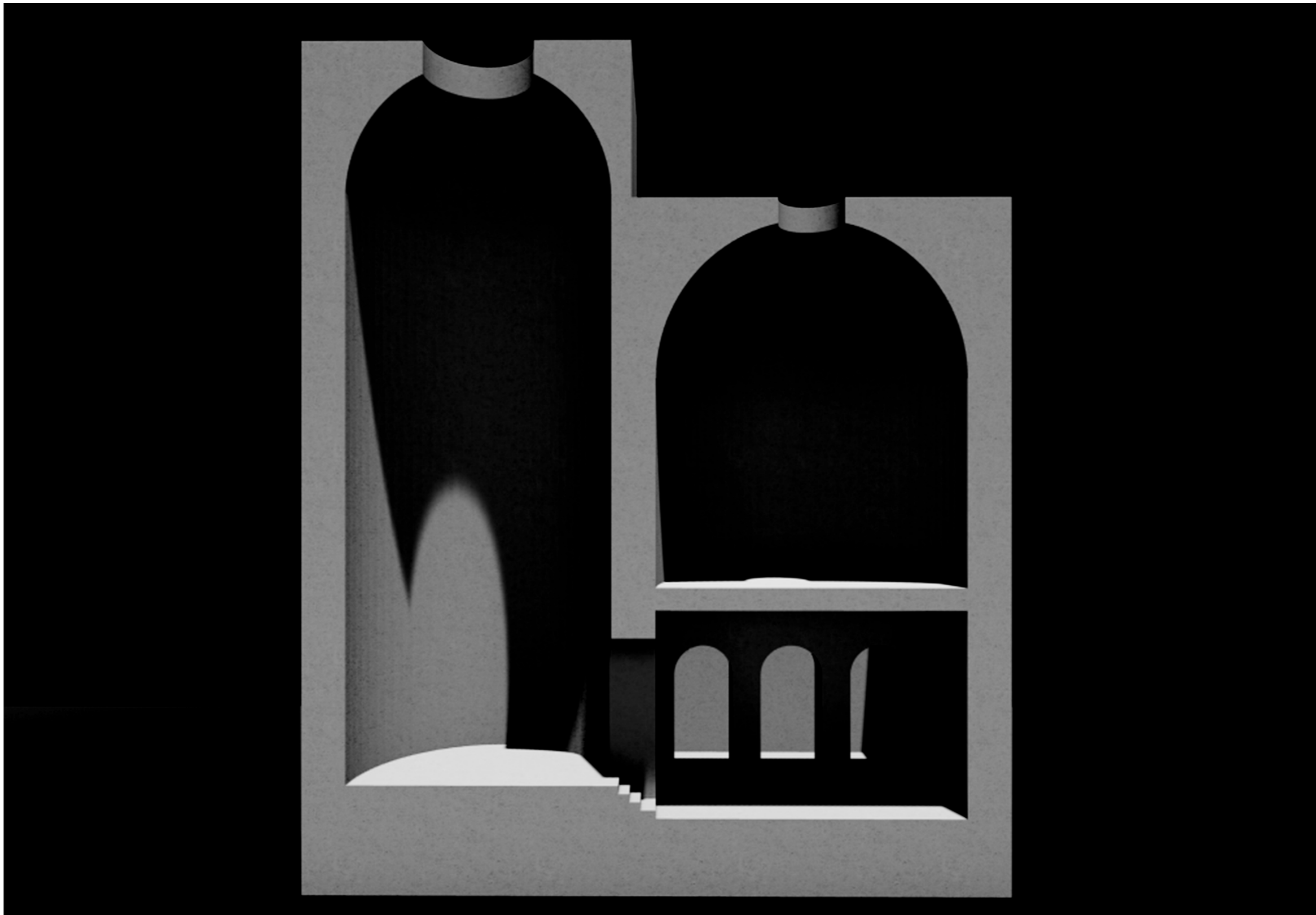

LEHMBAU
ARBEITSMODELL
ANTONIA LICHT

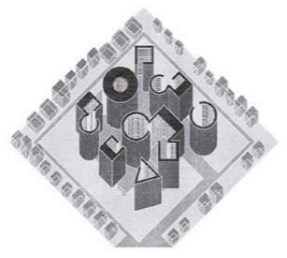
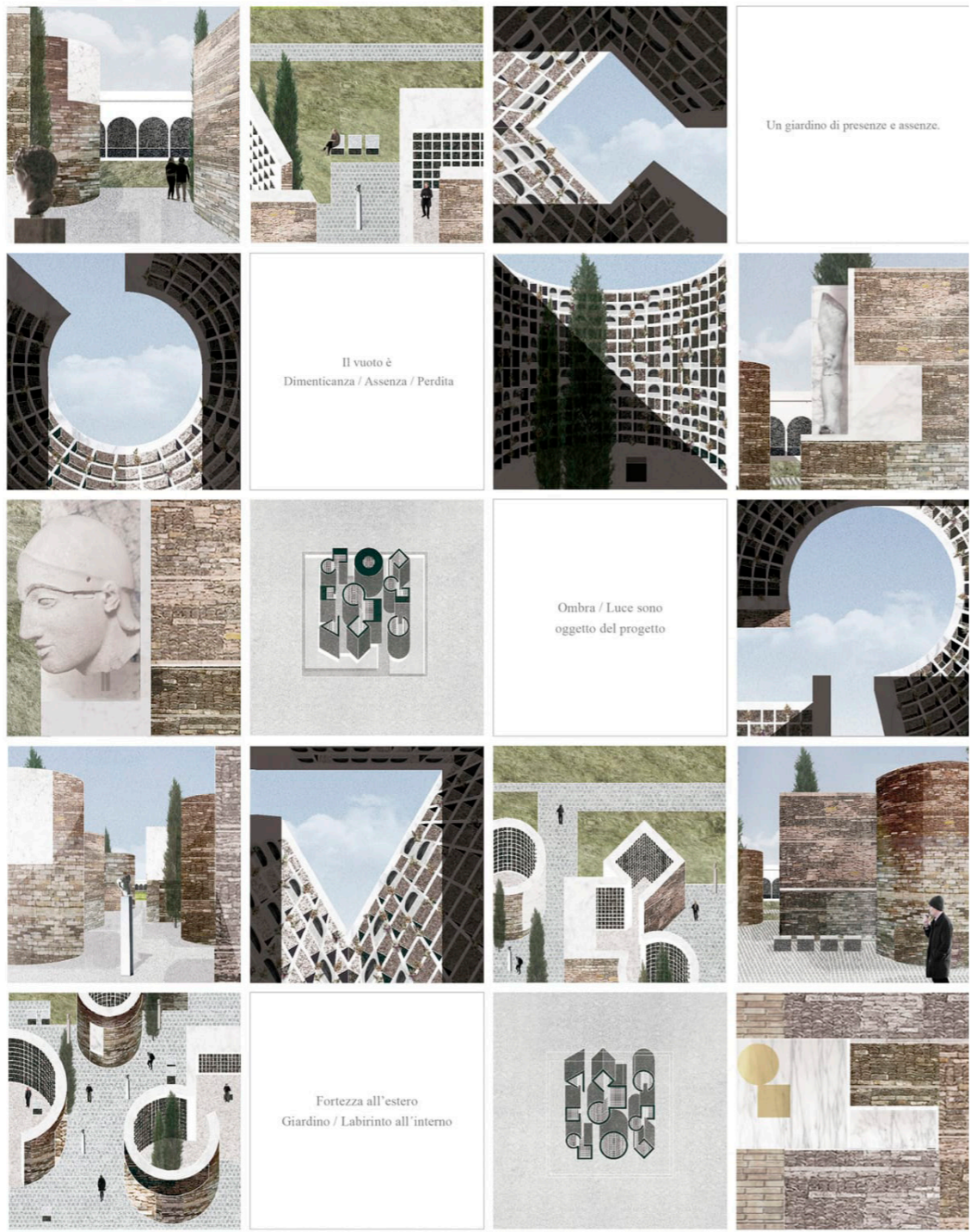

Frammenti concettuali

LEHMBAU
REFERENZ
ANTONIA LICHT



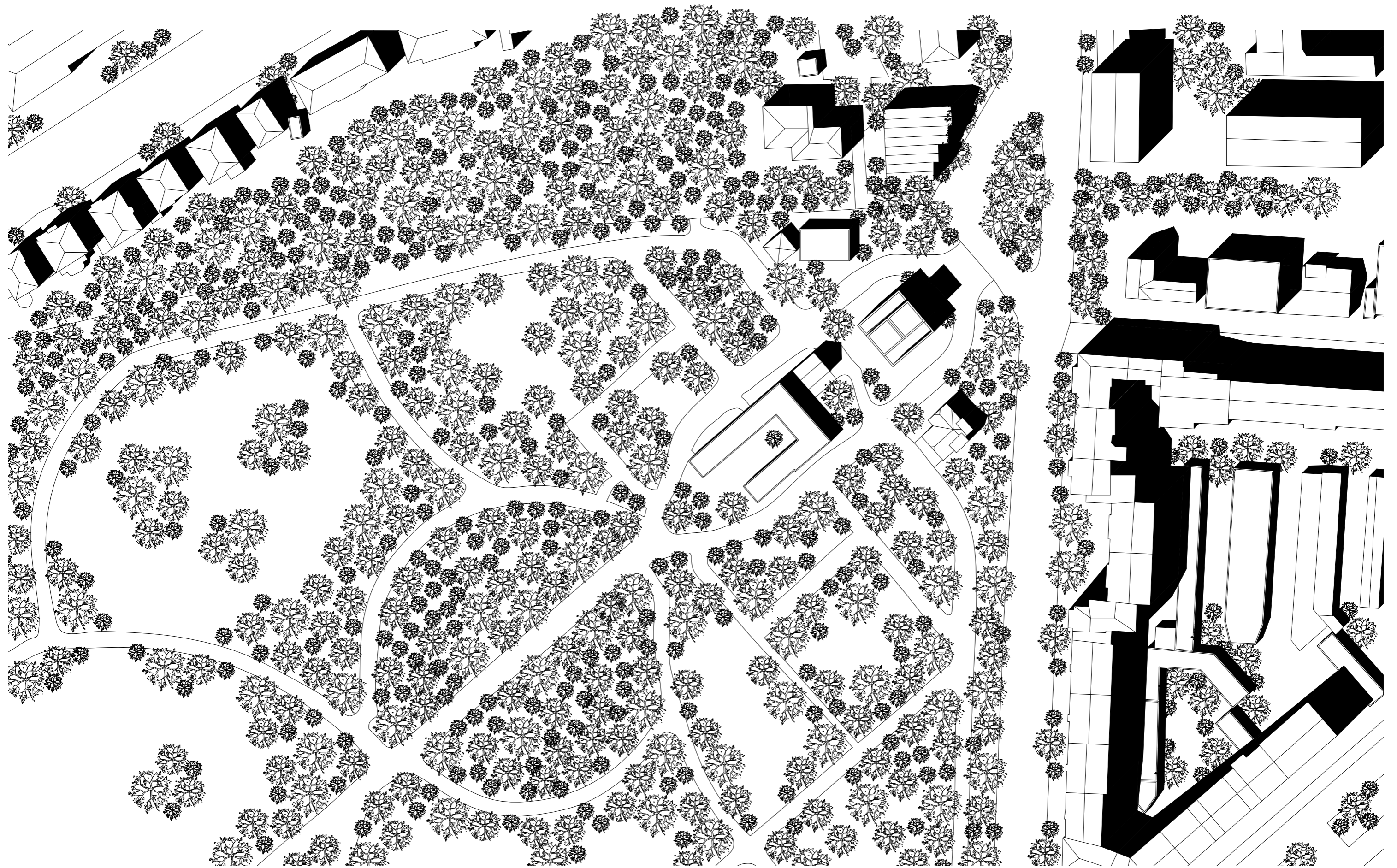

LEHMBAU
VERORTUNG
ANTONIA LICHT

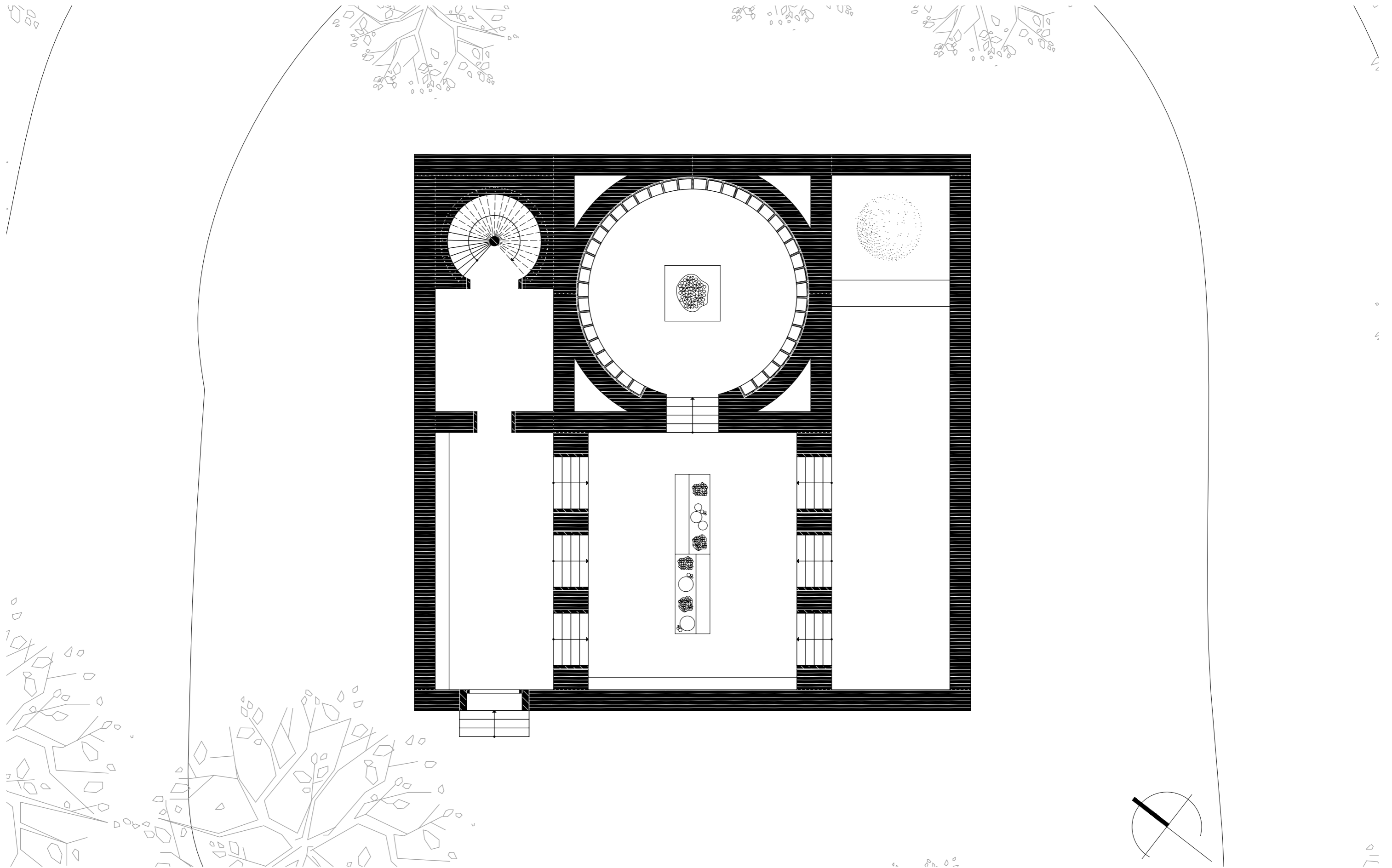

LEHMBAU
GRUNDRISS
ANTONIA LICHT

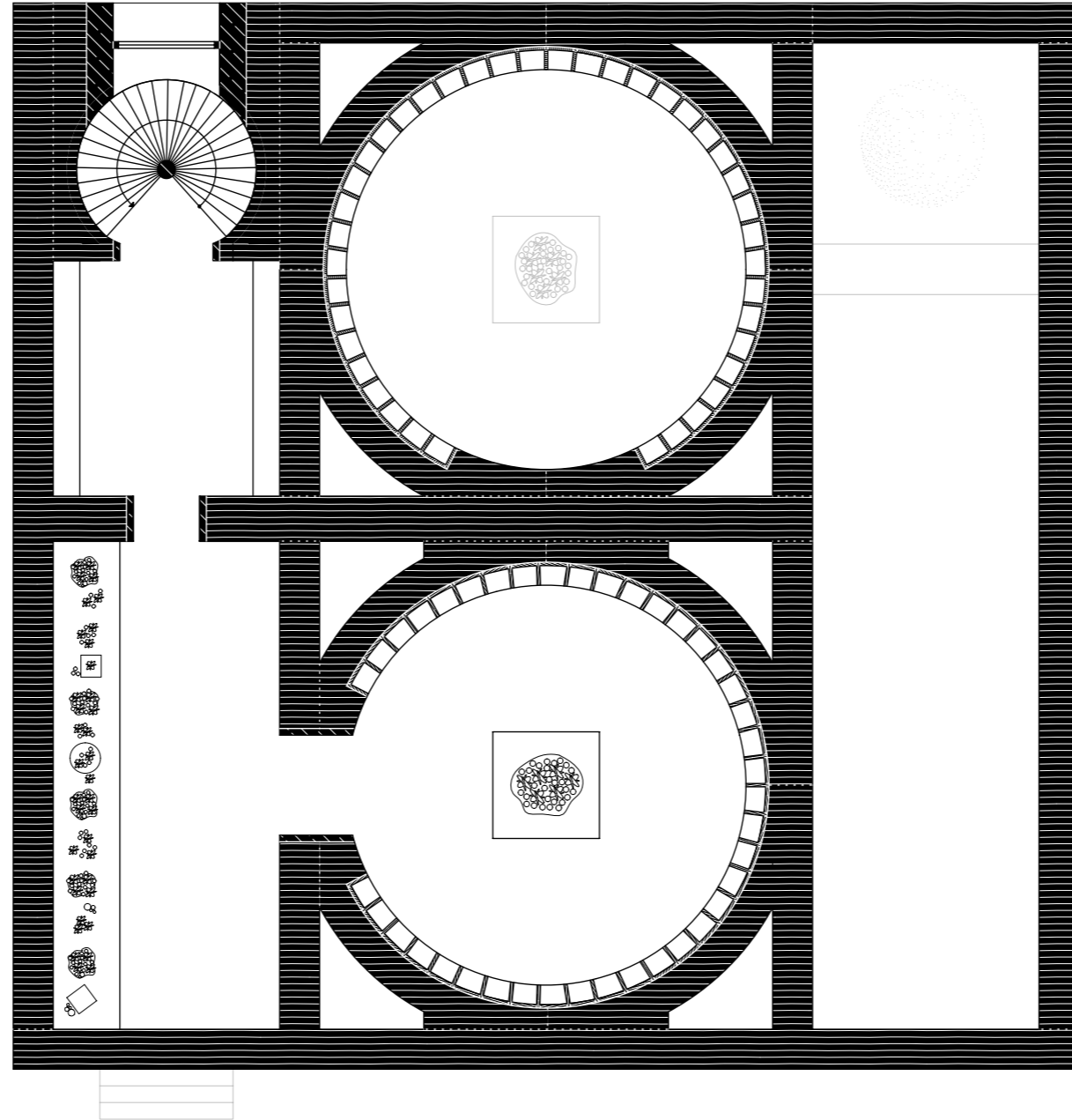

LEHMBAU
GRUNDRISS
ANTONIA LICHT

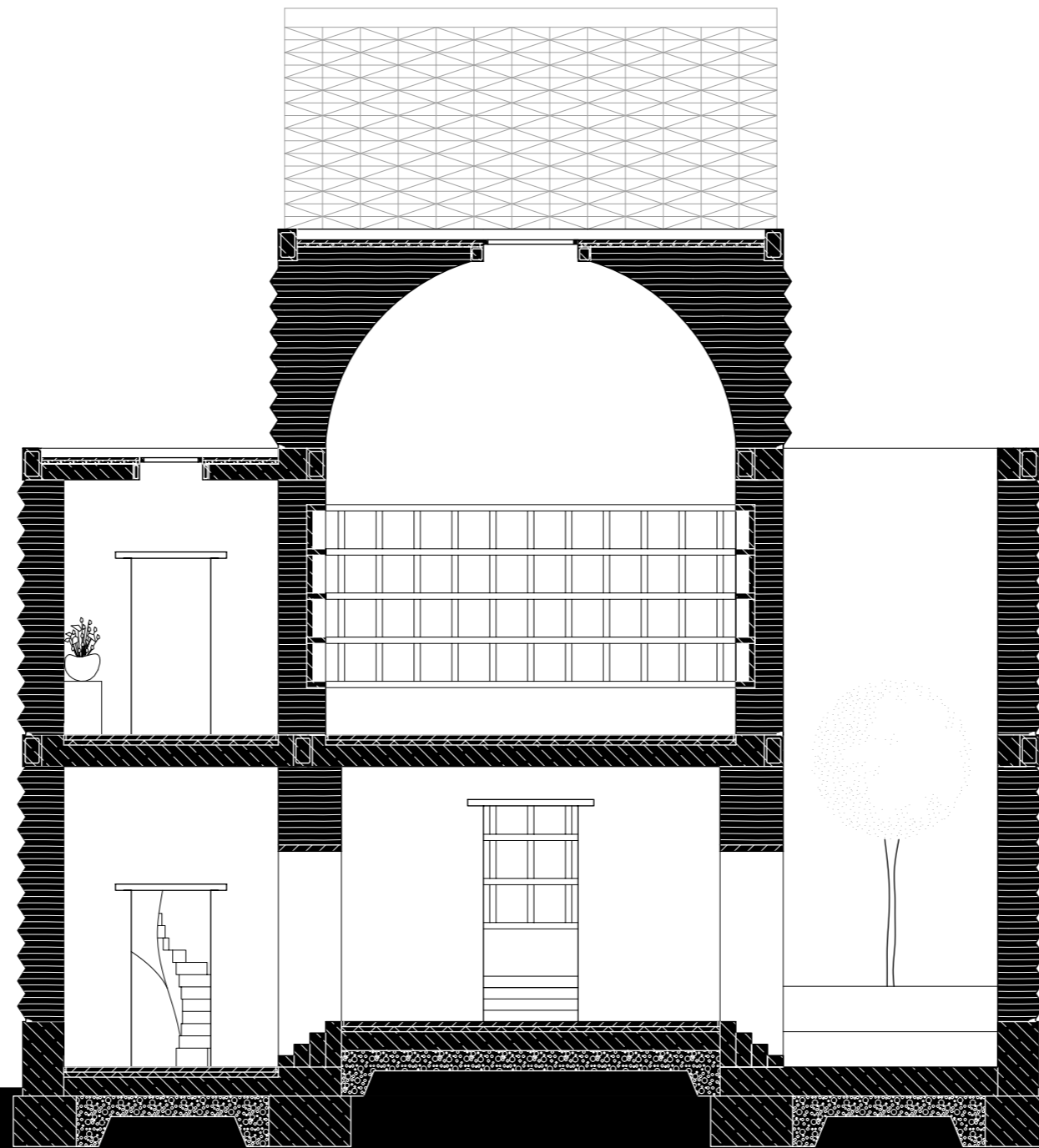

LEHMBAU
SCHNITT
ANTONIA LICHT



LEHMBAU
INNENPERSPEKTIVE
ANTONIA LICHT

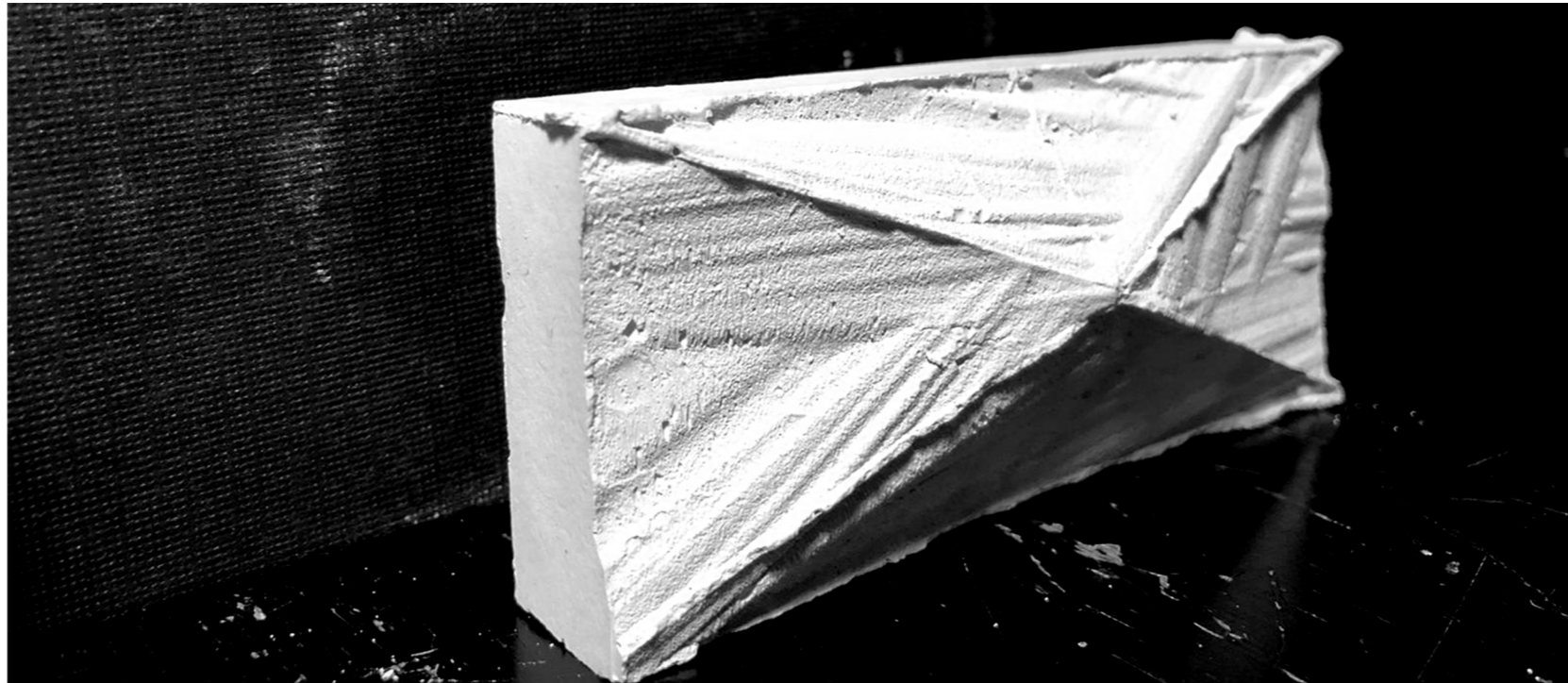
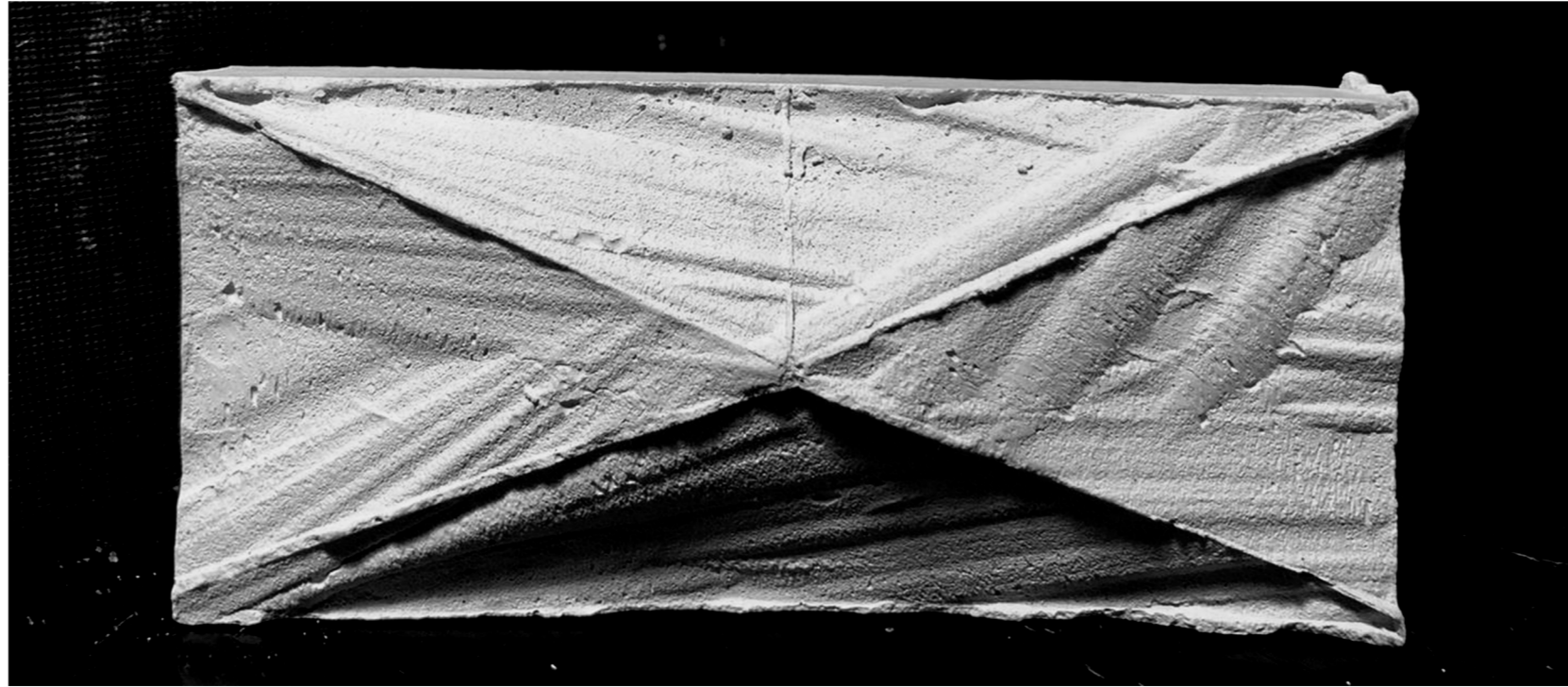

LEHMBAU
ENTWICKLUNG
ANTONIA LICHT

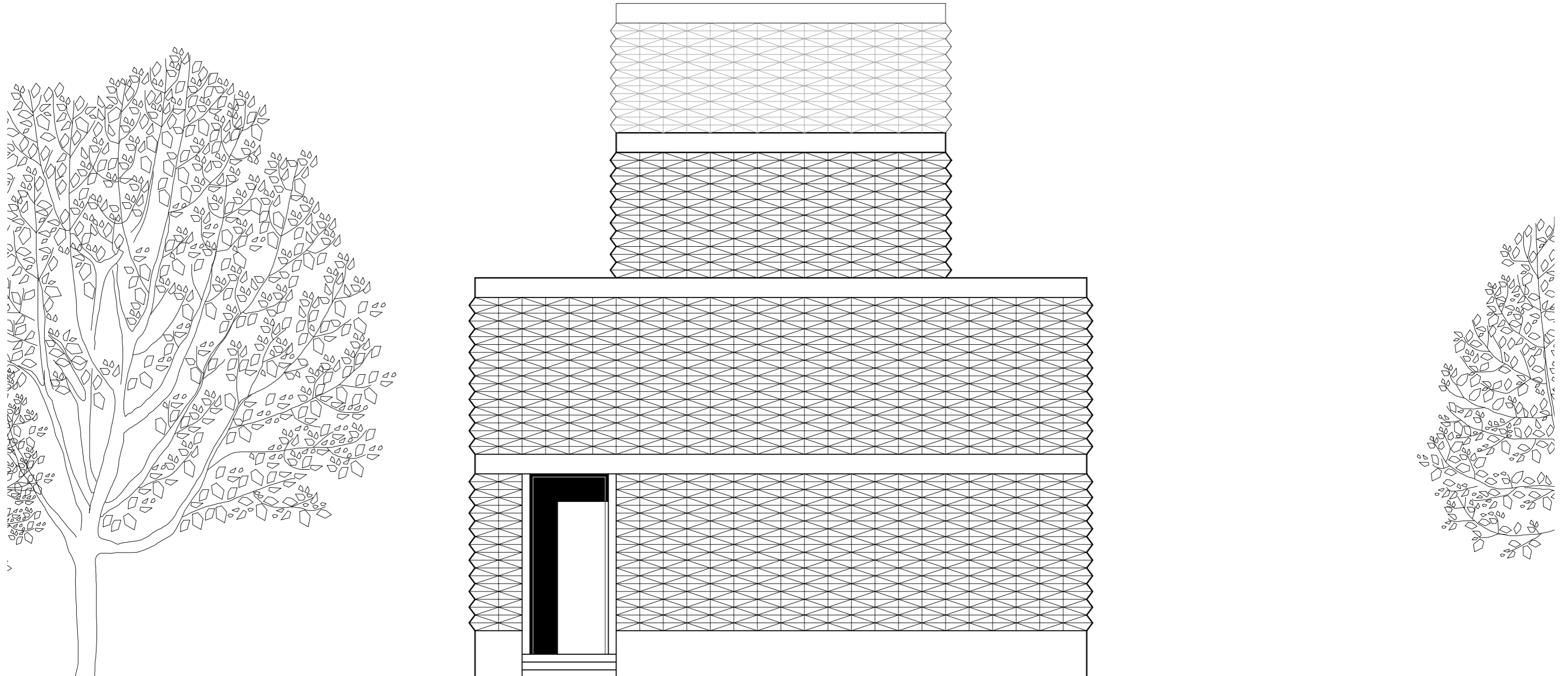

LEHMBAU
ANSICHT I
ANTONIA LICHT



LEHMBAU
RELIEF STUDIE
ANTONIA LICHT

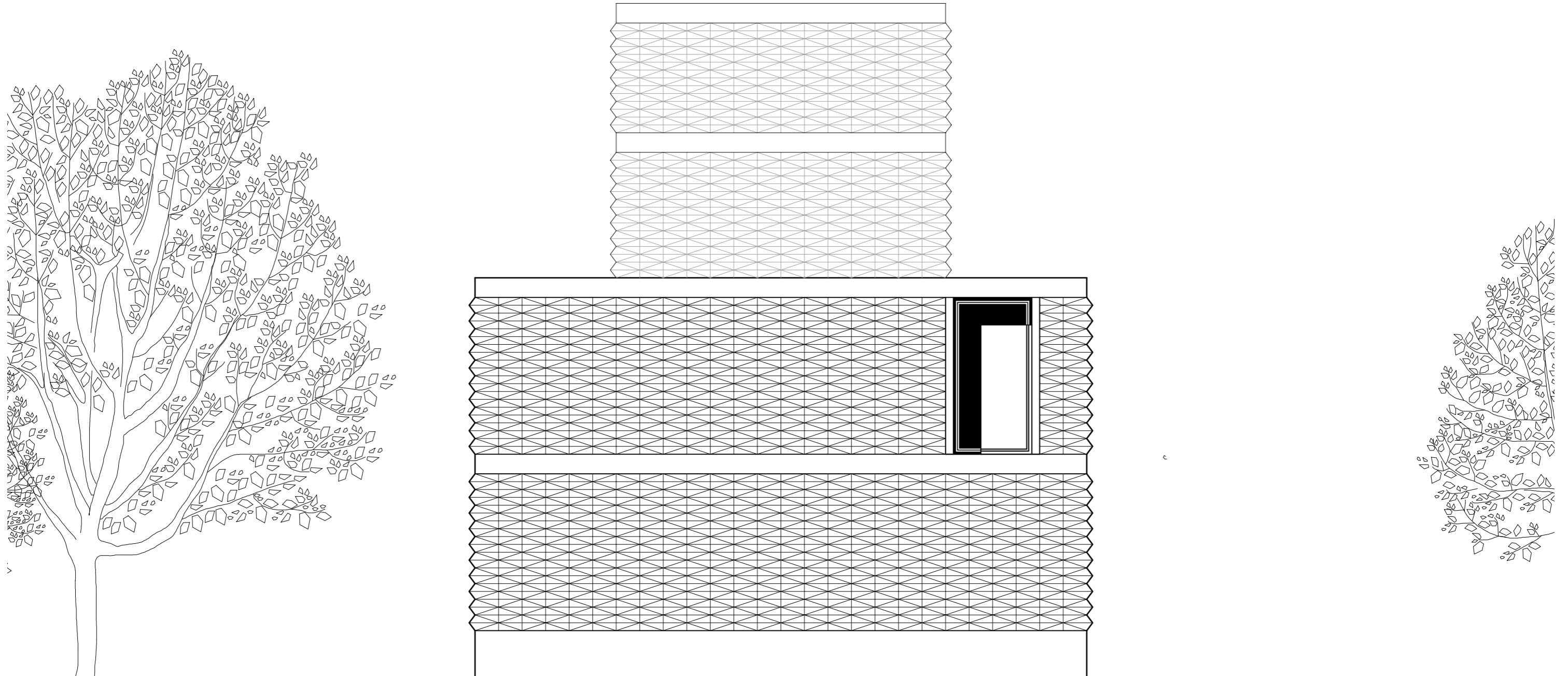

LEHMBAU
ANSICHT II
ANTONIA LICHT

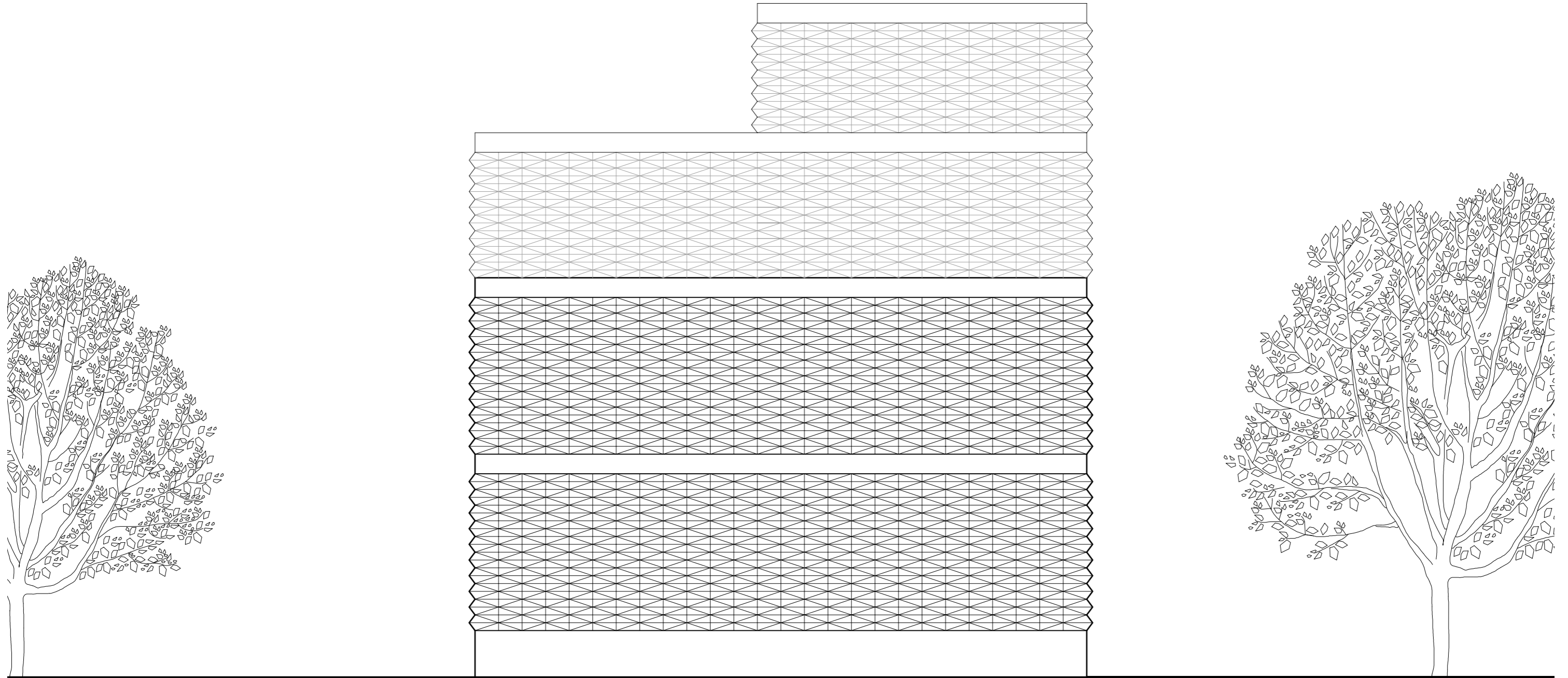

LEHMBAU
ANSICHT III
ANTONIA LICHT

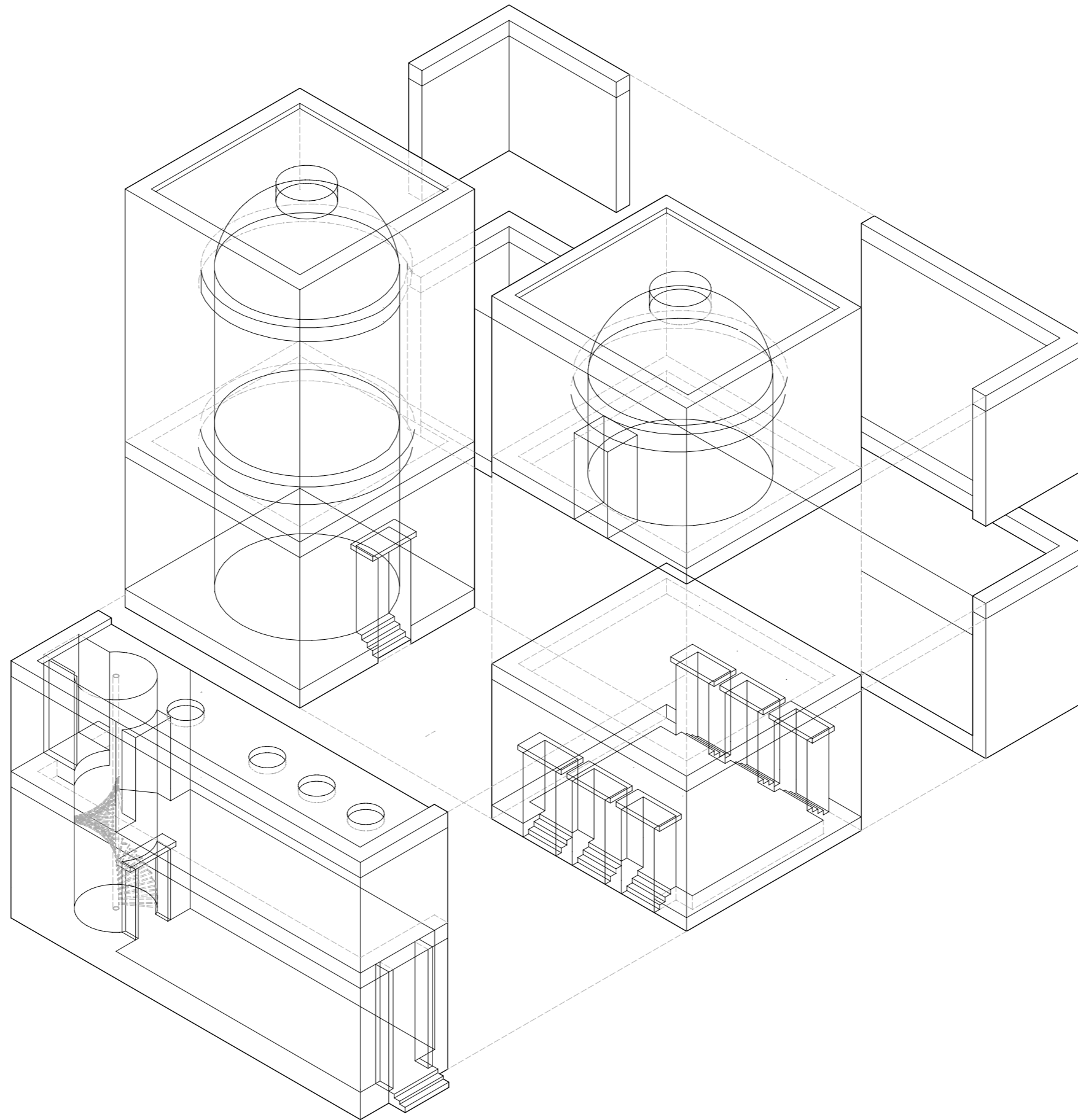

LEHMBAU
AXONOMETRIE
ANTONIA LICHT

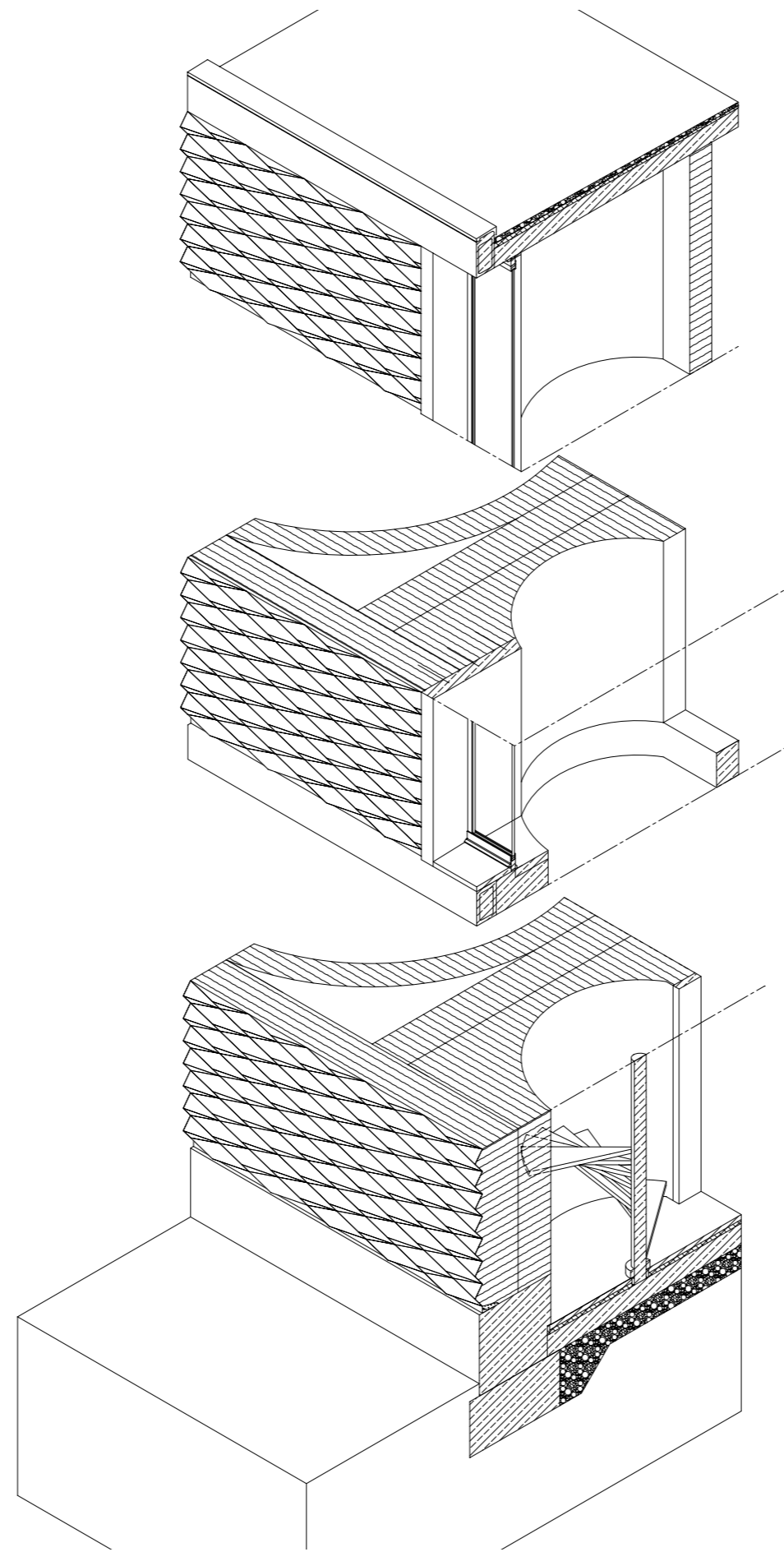

LEHMBAU
FASSADENSCHNITT
ANTONIA LICHT

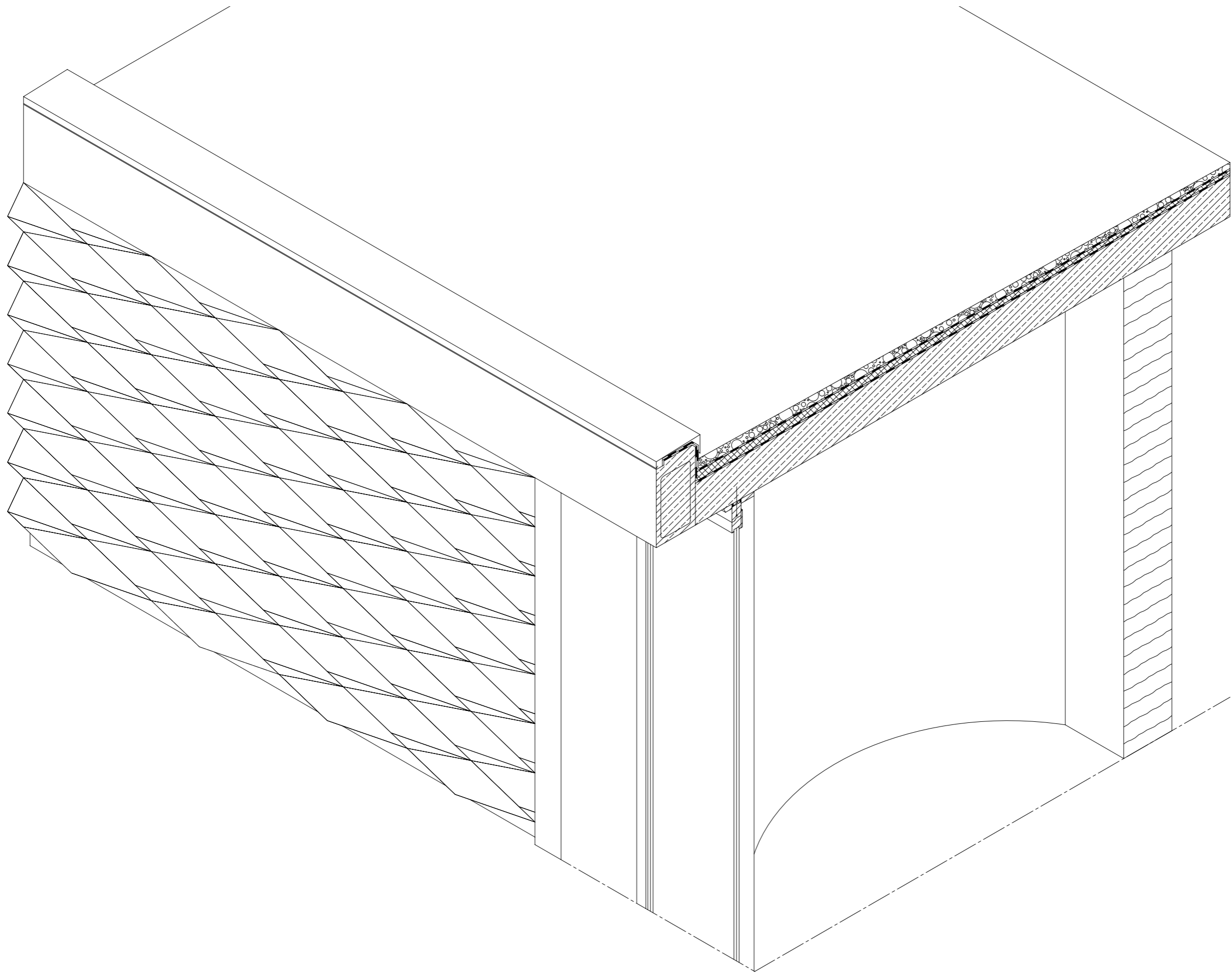

LEHMBAU
DETAIL I
ANTONIA LICHT

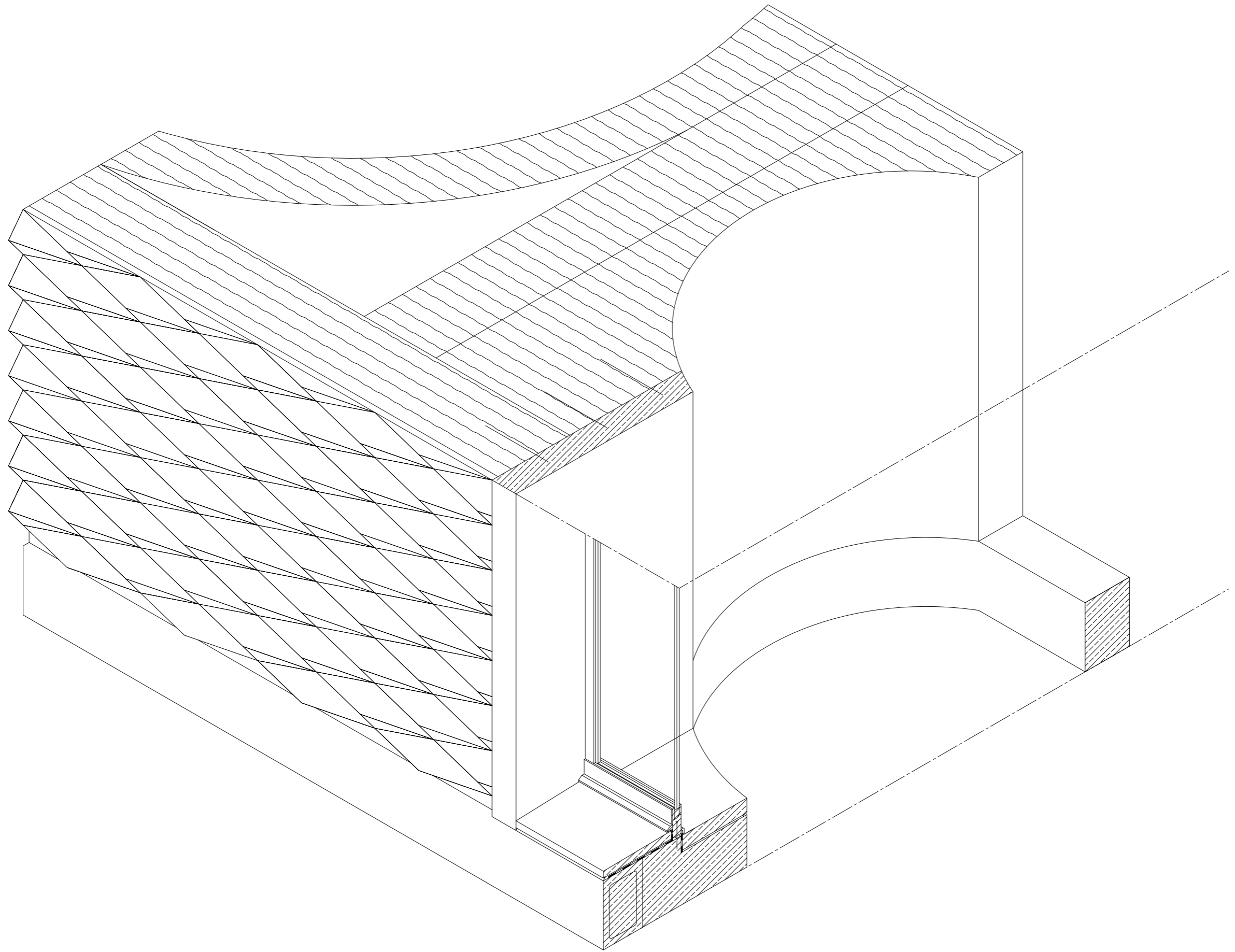

LEHMBAU
DETAIL II
ANTONIA LICHT

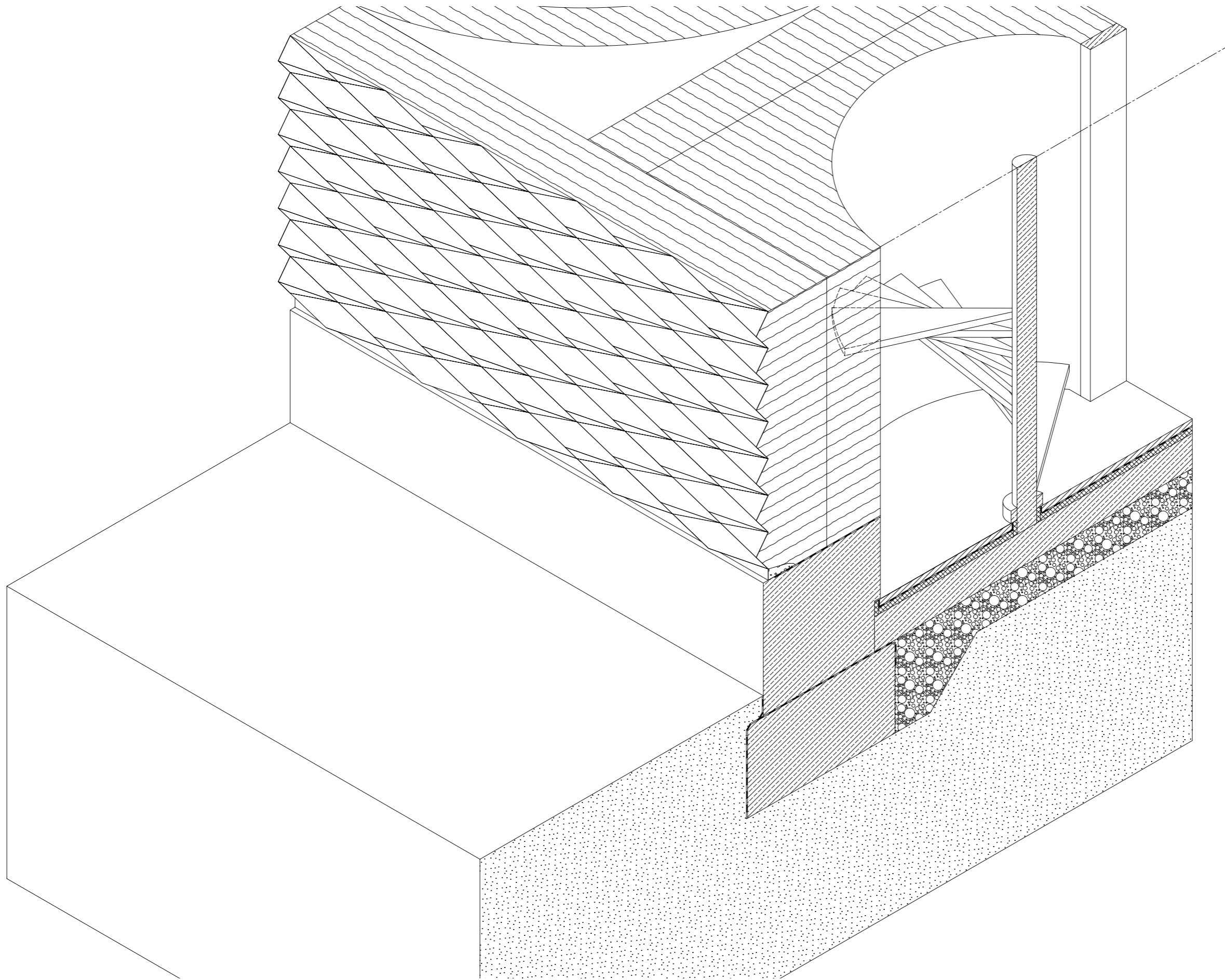

LEHMBAU
DETAIL III
ANTONIA LICHT